

# SG SERIES

SLIDE GATE VALVES

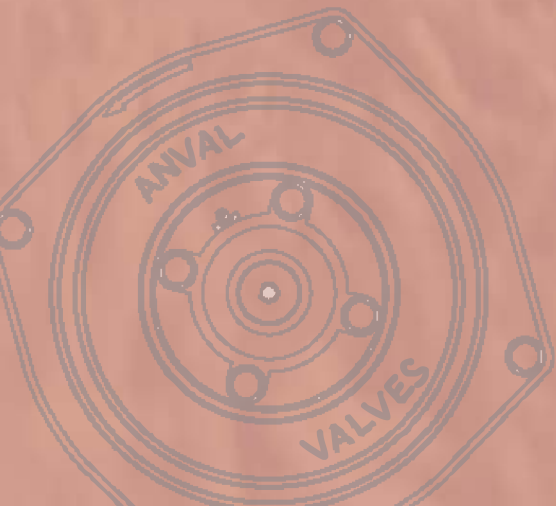
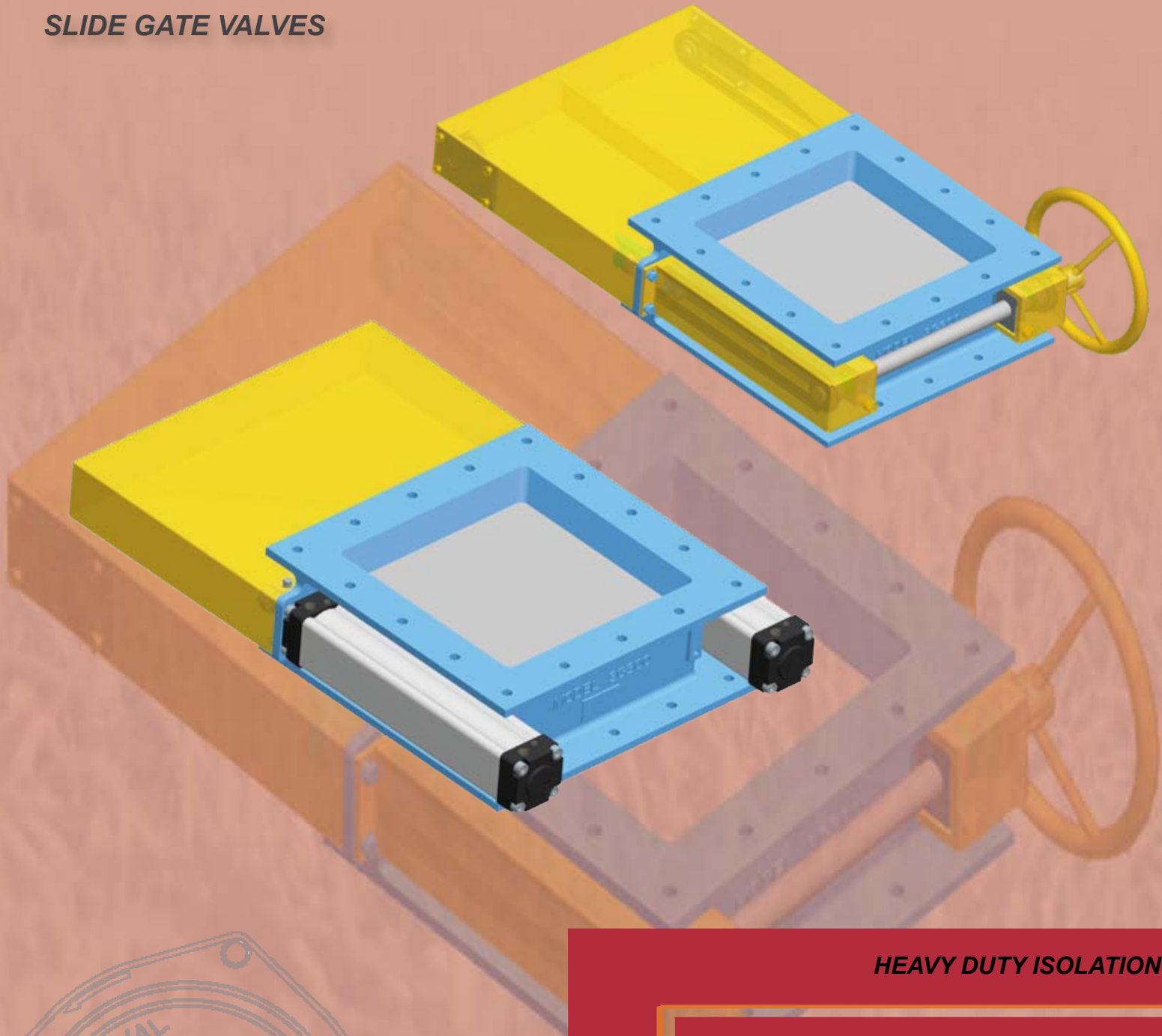

**HEAVY DUTY ISOLATION**

**MANUAL / PNEUMATIC / MOTORIZED**

**DEAL WITH PRESSURE DROPS**

**COMPACT & ROBUST**

**PNEUMATIC SLIDE GATE DIMENSIONS**

SG

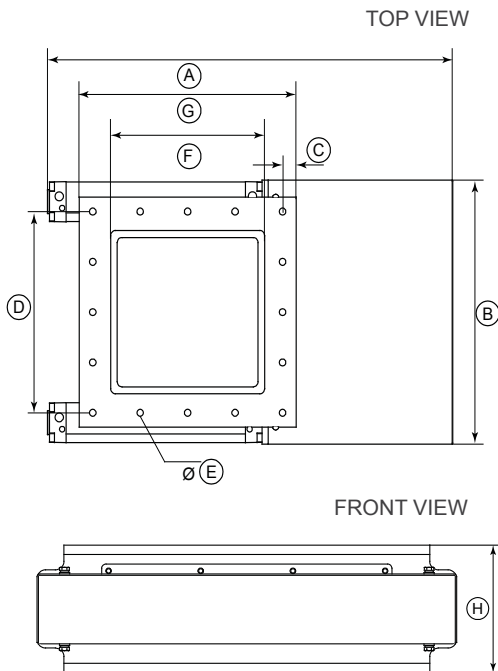

NAME	SG 300	SG 350	SG 400	SG 450	SG 750
A	803	907	1021	1155	1781
B	493	586	636	938	1420
C	27	28	30	30	50
D	4 SPACES @94 = 376	4 SPACES @106 = 424	5 SPACES @ 94 = 470	5 SPACES @114 = 570	6 SPACES @150 = 900
E	Ø 13	Ø 13	Ø 13	Ø 15	Ø 22
F	□305	□355	□400	□450	□750
G	□430	□480	□530	□630	□1000
H	150	160	136	190	250
<b>NET WEIGHT IN KGS</b>	52.5	75	87	153	431
<b>GROSS WEIGHT IN KGS</b>	58	84	96	165	458

ALL DIMENSIONS IN MM.

**MANUAL SLIDE GATE DIMENSIONS**

SG

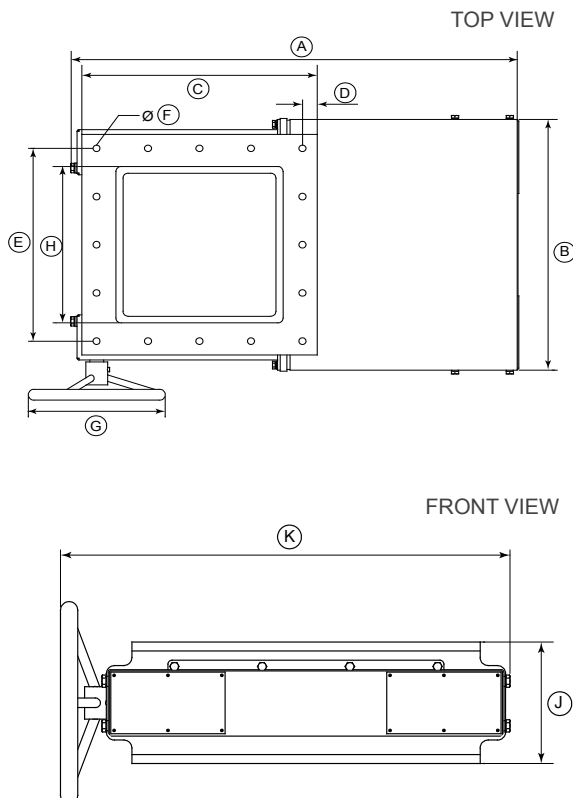

NAME	SG 300	SG 350	SG 400	SG 450	SG 750
A	818	935	1026	1169	1797
B	489	581	631	715	1120
C	□430	□480	□530	□630	□1000
D	27	28	30	30	50
E	4 SPACES @94 = 376	4 SPACES @106 = 424	5 SPACES @94 = 470	5 SPACES @114 = 570	6 SPACES @150 = 900
F	Ø13	Ø13	Ø13	Ø15	Ø22
G	Ø250	Ø250	Ø250	Ø250	Ø400
H	□305	□355	□400	□450	□750
J	150	160	160	190	250
K	555	642	692	800	1250
<b>NET WEIGHT IN KGS</b>	57	77	87	140	402
<b>GROSS WEIGHT IN KGS</b>	65	85	98	153	425

ALL DIMENSIONS IN MM.

## BLADE

STANDARD BLADE MATERIAL : Cast Iron

SG

## ACTUATORS

SG

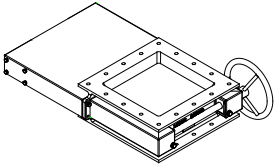

HAND WHEEL

- HAND WHEEL / MANUAL : Chain and Clamp Arrangement

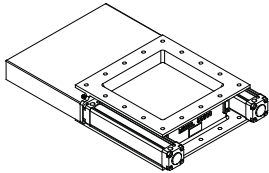

PNEUMATIC

- PNEUMATIC : Double cylinder double acting piston

## SG VALVE BODY

SG

STANDARD MATERIAL CONSTRUCTION : Cast Iron

SEALING : Rubber Sealing (temperature < 200 ° C)  
Fiber glass Seal (temperature > 200 ° C)

### OPTIONS AVAILABLE

BODY MATERIAL : Cast Iron

## SIZE RANGE AND APPLICATION

SG

OPENING SIZE RANGE : 300 mm to 750 mm

### APPLICATION

- Silos and hoppers for all bulk material applications.



PNEUMATIC

- HEAVY DUTY ISOLATION.
- CAST IRON MATERIAL CONSTRUCTION.
- MANUAL, PNEUMATIC AND MOTORISED ACTUATION.
- COMPACT AND ROBUST DESIGN.
- CAN HANDLE HIGHER TEMPERATURE

- DEAL WITH PRESSURE DROPS
- “ANVAL TRIGGER LOCK TECHNOLOGY” FOR BETTER SEALING
- EASY TO MAINTAIN.



HAND WHEEL / MANUAL

## OUR LOCATIONS

Rev : Mar 2016 - 3

### AUSTRALIA

+61 8 9726 0988

### INDIA

+91 44 47400 505 / 432

### UNITED KINGDOM

+44 (0) 207 117 2067

### SINGAPORE

+61 8 9726 0988